

L2021

The Ancient Capital
nuder
moonlight



NOTICE OF ASSEMBLE

Tips for assembling

1. Pictures shown on the package may be slightly different from the actual product.
2. All the materials are taken in the operation step, put the remaining materials back into the original pocket until the installation is completed. (Avoid material loss during installation)
3. The dimensions indicated in the step diagram are "cm".
4. If there have template paper material, please cut the material according to the template to avoid mistakes..
5. According to the part rule example at the bottom of this page, refer to the part on the part number drawing, find the material object and compare with the material list, confirm and install. (Wooden parts only)
6. Glue should not be applied too much, so as not to dry longer, overflow will affect the effect of the finished product.
7. Part shapes may differ from the photographs depending on the production batch

Tips for Assembling Wood



Find the corresponding block number, use a knife in the connection point gently press, you can take out the wood.

Use a knife to smooth out the burr

Or use sandpaper to smooth out the burr

Testing on LED function

Be sure to test the LED lights before making the lighting, note that the LED white wire to the negative, gray wire to the positive reference to the following figure operation test.

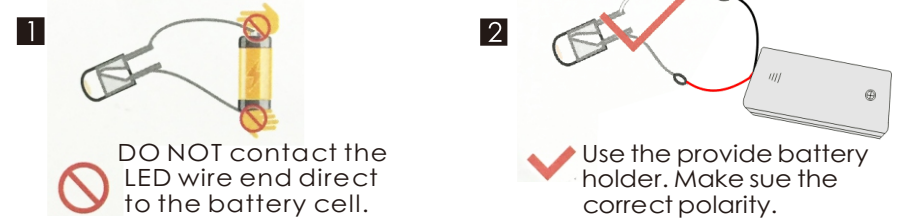

1 DO NOT contact the LED wire end direct to the battery cell.

2 Use the provide battery holder. Make sue the correct polarity.

How to assemble the battery holder

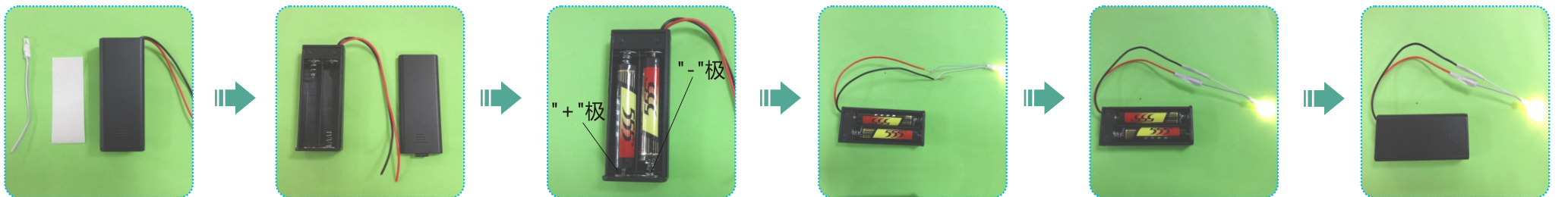

1. Material and tools needed:
- Battery holder, LED bulb, tape, screw driver and 2 piece AAA size battery(not provided)

2. Use screw driver and take the lid off from the battery holder.

3. Insert the battery take notes on the polarity.

4. Connect the red wire to grey wire. Connect the black wire to white wire.

5. Wrap the exposed wire with the tapes.

6. Place the box lid and fastness with screw driver.

Examples of parts rule:

A01: The parts are directly in the box; B01: The parts are in the B bag; C01: The parts are in the C bag, and so on (Note: The printing paper is displayed in the step A28-01: The printing paper is placed directly in the box, The part number is A28-01)
Note: Materials A23, A24, A25 and A26 are placed in the material bag A.

Contents

Name	Materials Package
Printing paper	A bag A28、A29、A30(all printing paper and template paper are set in the A28、A29、A31 paper accessories, a total of 9 pieces of A3 single-sided printing Paper + 1 piece cardboard paper)
cupboard	A bag + B bag + M bag + J bag + printing paper page 3
kitchen accessories	J bag + K bag + L bag + M bag + N bag + printing paper page 4-5
undry rack	A bag + B bag + J bag + K bag + L bag + N bag + printing paper page 5-7
dining table	B bag + J bag + K bag + L bag + M bag + N bag + printing paper page 7-9
tea table	A bag + B bag + J bag + K bag + L bag + M bag + N bag + printing paper page 9-10
japanese koto	A bag + C bag + K bag + L bag + M bag + printing paper page 10
bed	A bag + C bag + L bag + M bag page 10-12
bathroom accessories	A bag + C bag + J bag + K bag + printing paper page 12
cabinet	A bag + C bag + K bag + M bag + P bag + printing paper page 12-13
bookcase	A bag + C bag + printing paper page 13-14
writing desk	A bag + D bag + K bag + L bag + M bag + printing paper page 14-15
lights	A bag + D bag + L bag + M bag + P bag + printing paper page 15-16
umbrella	J bag + K bag + L bag + P bag + printing paper page 16-17
potted plant	J bag + K bag + L bag + M bag + N bag + printing paper page 17-18
door and window	A bag + D bag + M bag + printing paper page 18
wooden shoe	A bag + D bag + printing paper page 18-19
wall&stairs&raft	A bag + E bag + L bag + P bag + printing paper page 19
outer frame assembly	A bag + printing paper page 20-21
first floor assembly	A bag + D bag + E bag + printing paper page 21-22
bathroom wall panel	A bag + J bag + L bag + printing paper page 23
door and window on the second floor	E bag + M bag + printing paper page 23
second floor assembly	A bag + E bag + F bag + K bag + L bag + P bag + printing paper page 23-25
roof tile	A bag page 26
window, doors and lighting on the third floor	A bag + F bag + K bag + M bag + P bag + printing paper page 26-27
third floor assembly	A bag + E bag + G bag + K bag + N bag + P bag + printing paper page 27-29
hot spring	A bag + G bag + J bag + K bag + P bag page 29-30
rockery	H bag + K bag + P bag page 30-31
ground lamp	A bag + H bag + K bag + L bag + M bag + N bag + P bag + printing paper page 31
plants	A bag + L bag + N bag + printing paper page 31
garden accessories	A bag + H bag + L bag + printing paper page 32
garden assembly	H bag + L bag + M bag + N bag + P bag + printing paper page 32-35
Installation of battery box	P bag + printing paper page 35-36



Welcome to the DIY world, now follow me to start.

Thumbnail of material list (reference only)



Thumbnail of printing paper & template paper (reference only)

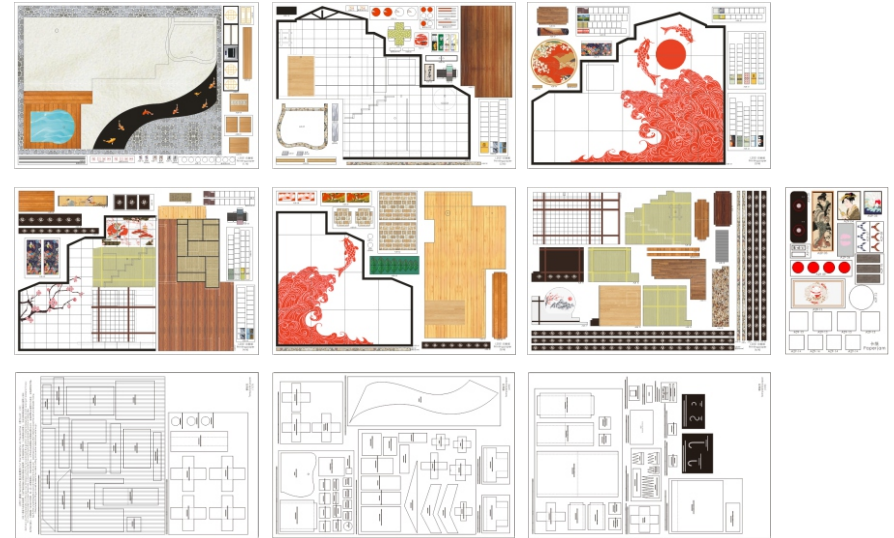

Symbol description used

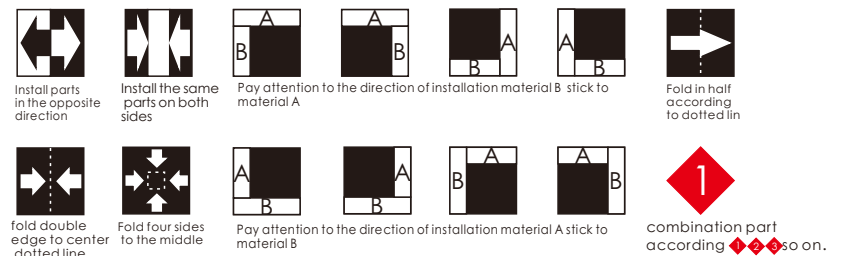

Cupboard

Before making, please cut out A23-1, A23-2, A23-3, A23-4, A23-5, A23-9, A23-11, A23-12, A23-13, A23-16 and A23-18 in A23. Cut out the M11 according to the template paper before making this step.

M11 (sink)

J10 J10

1 Block splice plan

2

3

4

5

28-01
Make a 90 degree right angle according to the dotted links

6

7

8

9

In the same way, make 2 pieces

10

11

M11

12

Glue all four sides together.

13

14

15

16

17

18

19

20 (front view)

Place B04 in the middle of B05

21

22

23

24

25

26

27

28

29 (Left side)

(Right side)

30

Kitchen Gadget

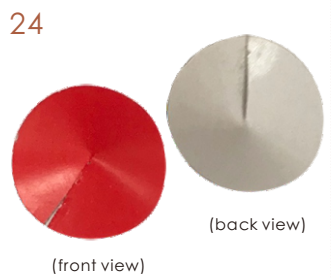
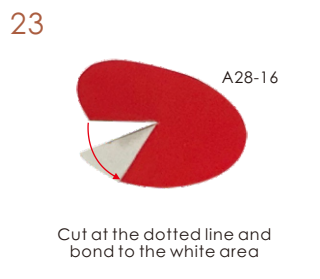
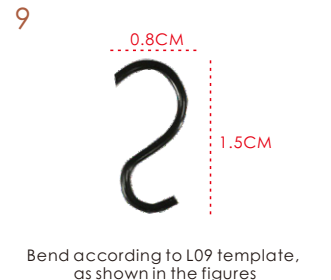
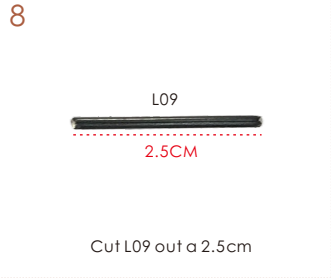

<p>25</p>  <p>A28-18</p>	<p>26</p>  <p>A28-18</p>	<p>27</p>  <p>A28-17</p> <p>In that same man, make the rest of the dish. (Note that only one red and one white dish is needed here)</p>	<p>28</p> 	<p>29</p> 	<p>30</p>  <p>M12</p> <p>Roll up M12, as shown in the figures</p>
<p>31</p>  <p>M12</p> <p>J08</p> <p>Insert M12 into J08 round hol</p>	<p>32</p>  <p>N14</p>	<p>33</p>  <p>J10</p> <p>J13</p>	<p>34</p>  <p>Food Jar</p> <p>Seasoning flask</p> <p>Seasoning flask</p> <p>plate</p>	<p>35</p>  <p>L08</p> <p>2CM</p> <p>Cut L08 out a 2cm</p>	
<p>36</p>  <p>0.8CM</p> <p>1CM</p> <p>Bend according to L08 template, as shown in the figures</p>	<p>37</p>  <p>J09</p>	<p>38</p>  <p>J12</p>	<p>39</p>  <p>J11</p> <p>J11</p>	<p>40</p>  <p>M02 kitchen towel</p>	
<p>41</p>  <p>A29-01</p>	<p>Sundry Rack</p>  <p>Please cut out A23-14 in A23 before making.</p> <p>A28-10</p> <p>A28-20</p> <p>A28-19</p> <p>A23-14</p> <p>B09</p> <p>B11</p> <p>B13</p> <p>B10</p> <p>B12</p> <p>B12</p> <p>B14</p> <p>B14</p> <p>L10</p> <p>K07</p> <p>J14</p> <p>L19</p> <p>N22</p> <p>N23</p> <p>A28-21</p> <p>A28-28</p>			<p>1</p>  <p>A23-14</p> <p>A28-21</p>	
<p>42</p>  <p>pot</p> <p>jug</p>	<p>2</p> 				

<p>3</p>	<p>4</p>	<p>5</p>	<p>6</p>	<p>7</p>	<p>8</p>
<p>9</p>	<p>10</p>	<p>11</p>	<p>12</p>	<p>13</p>	<p>14</p>
<p>15</p>	<p>16</p>	<p>17</p>	<p>18</p>	<p>19</p>	<p>20</p>
<p>21</p>	<p>22</p>	<p>24</p>	<p>25</p>	<p>26</p>	<p>27</p>
<p>28</p>	<p>29</p>	<p>30</p>	<p>31</p>	<p>32</p>	<p>33</p>

34

K07

35

N23

Dining table

Please cut out M02, M03, M04, M08 and M13 according to the template before making.

M03 (yellow sushi)
M05 (light orange sushi)
M04 (orange sushi)
N22 (table cushion) *4pieces
N23 (A29-13 (4个))
M08 (wine bottle) A28-11
M02 (yellow sushi)
M02 (orange sushi)
M08 (wine bottle) A28-12

M13 (table cloth)
M13 (table cushion)
M13 (table cushion)
M13 (table cushion)
M13 (table cushion)

B16
B17
B18
B15
B19
J14 J14
J16 J16 J16
L12
L15
A28-08

1

B15
B16

2

B15

3

back view

M13 (table cloth)
Fold up 1 cm on both sides

4

front view

5

M13 (table cloth)

6

B17
B18

7

In the same way, make 4pieces

8

A29-13
M02 (table cushion)

9

A29-13
M02 (table cushion)

10

M13 (table cushion)

11

12

13

front view

14

In the same way, make 4pieces

15

M04 (orange sushi)
M02 (orange sushi)

16

17

0.3CM
Cut out width approx. 0.3cm

18

0.3CM
0.8CM
Then cut out a length of about 0.8cm

19

A28-08
Cut out 1.5cm

20

A28-08

21

22

M03 (yellow sushi)
M03 (yellow sushi)
In the same way, make 2pieces yellow sushi

<p>23</p>  <p>B19</p>	<p>24</p>  <p>N22</p>	<p>25</p>  <p>J16</p> <p>apply the inside with glue</p>	<p>26</p>  <p>N22</p>	<p>27</p>  <p>Cut a small piece of M03 at random.</p>	<p>28</p>  <p>M03</p>
<p>29</p>  <p>L14</p> <p>Cut a small piece of L14, about 0.1 cm thick</p>	<p>30</p>  <p>L14</p>	<p>31</p>  <p>Cut in half</p>	<p>32</p>  <p>L14</p>	<p>33</p>  <p>J16</p> <p>Feel free to cut up some M02</p>	<p>34</p>  <p>M05</p> <p>0.8CM</p> <p>0.4CM</p> <p>Cut out a small piece of M05.</p>
<p>35</p>  <p>L14</p>	<p>36</p>  <p>K18</p>	<p>37</p>  <p>J16</p> <p>Feel free to cut up some M02</p>	<p>38</p>  <p>K18</p>	<p>39</p>  <p>N22</p>	<p>40</p>  <p>M03</p> <p>M02</p> <p>Cut out one M03 + M02 from the front of the sushi.</p>
<p>41</p>  <p>And cut it up at random and put it in J15.</p>	<p>42</p>  <p>J15</p>	<p>43</p>  <p>M04</p>	<p>44</p>  <p>N22</p>	<p>45</p>  <p>Cut a small piece of L15, about 0.1 cm thick</p>	<p>46</p>  <p>L15</p>
<p>47</p>  <p>L12</p> <p>J14</p>	<p>48</p>  <p>0.3CM</p>	<p>49</p>  <p>M08 (wine bottle)</p>	<p>50</p>  <p>L19</p> <p>3CM</p> <p>Separate L19 by 2pieces</p>	<p>51</p> 	<p>52</p> 

<p>53</p> 	<p>54</p>  <p>A28-11 A28-12</p> <p>In the same way, make 2 (Note that only one needs to be used here, and the other one is saved and placed in the back for use)</p>	<p>55</p>  <p>L09 1CM Cut out 8pieces</p>	<p>56</p> 	<p>57</p> 	<p>58</p>  <p>J01 J01 J01 J01</p>
<p>59</p>  <p>L09 L09 L09 L09</p>	<p>Tea table Please cut out A24-4 in A24 before making.</p>  <p>Please cut out M02, M05, M12 and M14 according to the template before making.</p>				<p>1</p>  <p>A28-36</p> <p>Fold up along the dotted line</p>
<p>2</p>  <p>A24-4 A28-36</p>	<p>3</p>  <p>B20 B20</p>	<p>4</p>  <p>J18 K03</p>	<p>5</p>  <p>K04</p>	<p>6</p>  <p>L09 1.3CM</p>	<p>7</p>  <p>0.5CM 0.7CM</p> <p>Bend according to L09 template, as shown in the figures</p>
<p>8</p>  <p>L09</p>	<p>9</p>  <p>J11</p>	<p>10</p>  <p>M12 J14</p> <p>Roll up M12 and put in J14</p>	<p>11</p>  <p>N11</p> <p>Trim off a few sprig</p>	<p>12</p>  <p>N11</p>	<p>13</p>  <p>Cut L13 into small pieces, about 0.1 cm thick</p>
<p>14</p>  <p>Cut to triangulate-shape as shown.</p>	<p>15</p>  <p>L14 L14 L14 L15</p>	<p>16</p>  <p>Please refer to the previous steps for how to make the dish.</p>	<p>17</p>  <p>L14 L13</p> <p>Put it on the white plate.</p>	<p>18</p>  <p>L15</p>	<p>19</p>  <p>M05 (light orange sushi) M05 (light orange sushi)</p> <p>Sushi production methods, please refer to the previous production steps.</p>

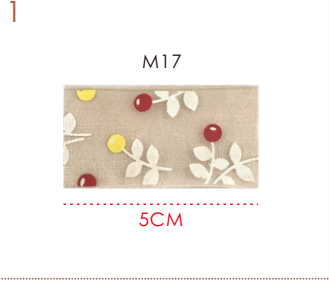
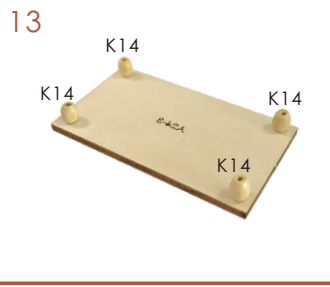
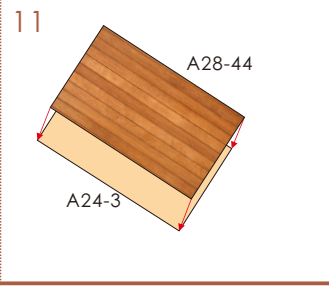
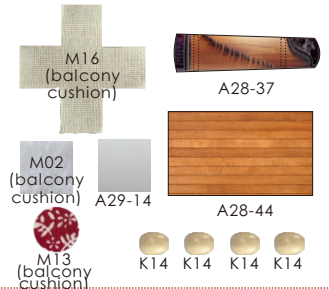
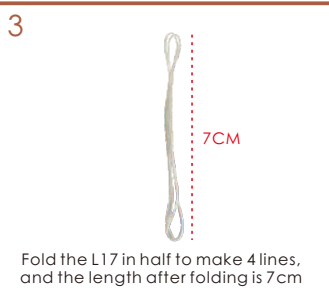
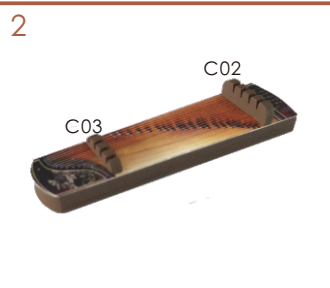
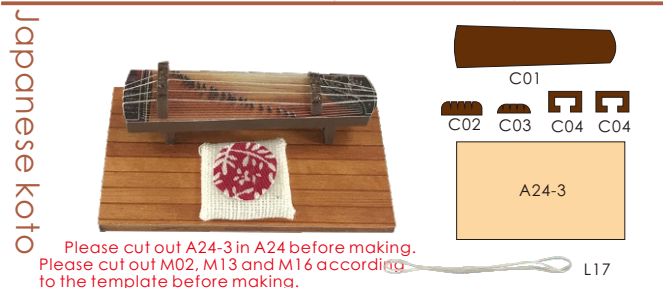

<p>2</p>  <p>M17</p> <p>Fold M17 in half and glue on both sides</p>	<p>3</p>  <p>L18</p> <p>Stuff with cotton.</p>	<p>4</p> <p>Glue the opening together</p>  <p>In the same way, make 2 pieces.</p>	<p>5</p> <p>M16 (big bed pillows)</p>  <p>Fold up all three sides and glue tightly</p>	<p>6</p> 	<p>7</p>  <p>In the same way, make 2 pieces.</p>
<p>8</p>  <p>Combine the 2 pieces and glue the three sides together</p>	<p>9</p>  <p>L18</p> <p>Stuff with cotton.</p>	<p>10</p>  <p>Glue the opening together</p>	<p>11</p> <p>M16 (big bed quilt)</p>  <p>Fold up both sides by 0.5cm.</p>	<p>12</p>  <p>Fold it in half and glue the sides together</p>	<p>13</p>  <p>L18</p> <p>Stuff with cotton.</p>
<p>14</p>  <p>Glue the opening together</p>	<p>15</p> <p>M02 (big queen bed sheets)</p> <p>A25-1</p> 	<p>16</p> 	<p>17</p> <p>C05</p> 	<p>18</p> <p>M16 (big bed quilt)</p> 	<p>19</p> <p>M15 (big bed quilt)</p> <p>1CM</p> <p>10.5CM</p>  <p>Fold the top inwards 1cm and glue the bottom to create a fringe effect</p>
<p>20</p>  <p>L21</p>	<p>21</p> <p>M17</p> 	<p>22</p> 	<p>23</p> 	<p>24</p> 	<p>25</p> <p>M16 (small bed pillows)</p> <p>M19 (small bed pillows)</p> 
<p>26</p>  <p>Glue three sides together.</p>	<p>27</p> <p>M13 (small bed pillows)</p> 	<p>28</p>  <p>Stuff with cotton.</p>	<p>29</p>  <p>Glue the opening together.</p>	<p>30</p>  <p>In the same way, make 2 pieces</p>	<p>31</p> <p>M16 (small bed sheet)</p>  <p>Fold up both sides by 0.5cm</p>

<p>32</p> <p>Fold it in half and glue the sides together</p>	<p>33</p> <p>Stuff with cotton.</p>	<p>34</p> <p>Glue the opening together.</p>	<p>35</p> <p>M16 (small bed quilt)</p> <p>Fold up all four sides and glue tightly.</p>	<p>36</p>	<p>37</p> <p>M02 (small bed quilt)</p>
<p>38</p> <p>Fold in half and glue</p>	<p>39</p> <p>L21</p> <p>L21</p>	<p>40</p> <p>M16 (small bed sheet)</p> <p>M16 (small bed quilt)</p> <p>0.8CM</p>	<p>41</p> <p>M15 (small bed quilt)</p>	<p>42</p> <p>(Pillows don't need to be glued to the bed for a while.)</p>	
<p style="writing-mode: vertical-rl; transform: rotate(180deg);">Bathroom Accessories</p> <p>C06</p> <p>C07</p> <p>A25-2</p> <p>A23-10</p> <p>A23-10</p> <p>A25-2</p> <p>A23-17</p>	<p>1</p> <p>C07</p> <p>C06</p>	<p>2</p> <p>C07</p>	<p>3</p> <p>Wooden chair</p>	<p>4</p> <p>K09</p> <p>A28-15</p>	
<p>J10</p> <p>K10</p> <p>J13</p> <p>M02 (spa towel)</p> <p>K09</p> <p>A28-23</p> <p>A28-15</p>	<p>5</p> <p>K10</p>	<p>6</p> <p>J10</p> <p>J13</p>	<p>7</p> <p>A23-17</p>	<p style="writing-mode: vertical-rl; transform: rotate(180deg);">Cabinet</p> <p>M09</p> <p>M10</p> <p>Please cut out A23-19 and A23-21 in A23 before making. Please cut out M09 and M10 according to the template before making.</p> <p>A23-19</p> <p>K11</p> <p>K11</p> <p>M10</p> <p>A23-21</p> <p>A23-21</p> <p>P01</p> <p>P01</p> <p>C08</p> <p>C10</p> <p>C12</p> <p>C13</p> <p>C09</p> <p>C11</p> <p>C14</p> <p>A28-47</p>	
<p>8</p> <p>A25-2</p> <p>A23-10</p>	<p>9</p>	<p>10</p> <p>A28-23</p>	<p>11</p> <p>Bathroom bucket</p> <p>Spa bucket</p> <p>M02 (spa towel)</p> <p>In the same way, make 2pieces.</p>		

1 M09
Crop as directed by the templates.

2

3

4 A23-21

5 A23-21 M10
And make another one in that same way.

6 A23-19 A28-47

7 A23-19

8 C10 C08

9 C09

10 C11

11 C12

12 C13

13 A23-19

14 P01 P01

15 K11 K11

16 C14

17 C14



A28-42

A28-53

A28-41

A28-51

A28-55

A28-40

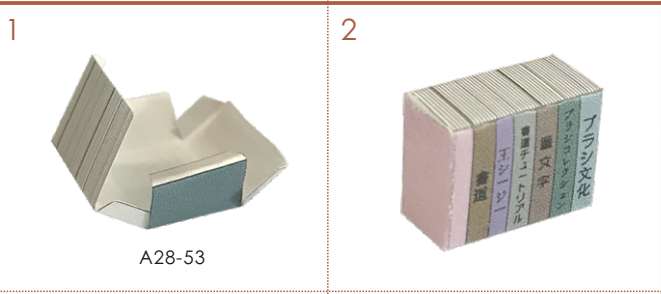

C16

C17

C18

C19

C20

A13

C15

A23-20

A28-24

A28-25

A28-26

A28-38

A28-54











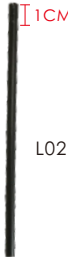











3 A28-51 A28-26
See page 6 for how to make the book

4 A28-42
Paste each set of books together

<p>5</p> <p>A28-38</p>	<p>6</p> <p>A28-54</p>	<p>7</p> <p>A28-41</p>	<p>8</p> <p>A28-53 A28-40</p>	<p>9</p> <p>A28-55</p>	<p>10</p> <p>C15 A28-25 C15</p>
<p>11 Bookcase plan</p> <p>C17 C19 C19 C19 C16 C16 C19 C19 C16 C18 A23-20 C17</p>	<p>12</p> <p>A23-20 A28-24</p>	<p>13</p> <p>A23-20</p>	<p>14</p> <p>C16 A23-20 A23-20(back view)</p>	<p>15</p> <p>C18 A23-20</p>	<p>16</p> <p>C19 C19 A23-20 Spacing 1.1cm each</p>
<p>17</p> <p>C20 A23-20</p>	<p>18</p> <p>C19 C19 A23-20</p>	<p>19</p> <p>C16 A23-20</p>	<p>20</p> <p>C19 A23-20</p>	<p>21</p> <p>C16 A23-20</p>	<p>22 (front view) C17</p> <p>C17 Paste C17 in the center</p>
<p>23</p> <p>A13</p>	<p>24</p> <p>A28-55</p>	<p>Writing Desk</p> <p>M12(study potted plants) A28-46</p> <p>Please cut out A24-2 in A24 before making. Please cut out M12 according to the template before making.</p>		<p>1</p> <p>L09 1CM L09 1.5CM L09 1.5CM</p>	<p>2</p> <p>K08</p>
<p>25</p> <p>A28-53 A28-41 A28-38 A28-54 A28-42 A28-51 A28-26</p>	<p>26</p> <p>A28-25</p>	<p>A24-2 D01 D01 D02 D02 K08 K13 L09 N23 A28-79</p>		<p>3</p> <p>Roll up M12 as shown.</p>	<p>4</p>

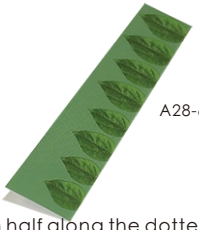
<p>5</p>	<p>6</p>	<p>7</p>	<p>Lighting</p> <p>Before making, please cut out A23-6, A23-7, A24-5 and A26-2 in A23, A24 and A26.</p> <p>Please cut out M07 according to the template before making.</p>										
<p>8</p>	<p>9</p>	<p>10</p>	<p>1</p> <p>2</p> <p>3</p> <p>Glue all four sides together.</p> <p>In that same way, make the rest.</p>										
<p>11</p>	<p>12</p>	<p>13</p>	<p>4</p>	<p>5</p> <p>In the same way, make 2pieces.</p>	<p>6</p>	<p>7</p>	<p>8</p>	<p>9</p>					
<p>4</p>	<p>5</p> <p>In the same way, make 2pieces.</p>	<p>6</p>	<p>10</p>	<p>11</p>	<p>10</p>	<p>11</p>	<p>12</p>	<p>12</p>	<p>13</p>	<p>14</p>	<p>14</p>	<p>15</p>	<p>15</p>

<p>16</p>  <p>L09 1.3CM*4pieces</p>	<p>17</p>  <p>L09 bend L09 as shown.</p>	<p>18</p>  <p>A28-59 A29-09</p>	<p>19</p>  <p>A29-09 Roll A28-59 around the edge of A29-09.</p>	<p>20</p>  <p>L05</p>	<p>21</p>  <p>L05</p>
<p>22</p>  <p>L09</p>	<p>23</p>  <p>In the same way, make 2pieces.</p>	<p>24</p>  <p>P02 P02</p>	<p>25</p>  <p>A28-58 L05</p>	<p>26</p>  <p>P02</p>	<p>27</p> 
<p>28</p>  <p>L06 L06</p>	<p>29</p>  <p>D12 D12 L09 L09 (front view) (side view)</p>	<p>30</p> 	<p>31</p>  <p>A28-60 A28-62 Fold up along the dotted line.</p>	<p>32</p>  <p>A23-7 A23-6 A B</p>	<p>33</p>  <p>A23-7 A23-6 A B</p>
<p>34</p>  <p>A23-6</p>	<p>35</p>  <p>A28-62</p>	<p>36</p>  <p>A28-60 A26-2</p>	<p>37</p>  <p>(front view)</p>	<p>38</p> 	<p>39</p>  <p>lantern lantern</p> <p>In the same way, make 2pieces.</p>
<p>Umbrella</p>  <p>J20 L02 K12 P01 A28-35</p>	<p>1</p>  <p>A28-34 Fold a trace along each dotted line.</p>	<p>2</p> 	<p>3</p>  <p>Flip to the back and fold the creased middle (red dotted line). Refer to the previous step.</p>	<p>4</p> 	

<p>5</p> 	<p>6</p>  <p>1CM</p> <p>L02(8CM)</p> <p>Make a small cut at the top, about 1 cm</p>	<p>Potted plant</p>  <p>Please cut out M08 and M12 according to the template before making.</p>					
<p>7</p>  <p>P01</p> <p>Thread P01 into L02 and fix it as shown.</p>	<p>8</p> 						
<p>9</p> 	<p>10</p>  <p>A28-35</p>	<p>1</p>  <p>N10</p> <p>Trim 2 pieces, approx. 3.5cm high.</p>	<p>2</p>  <p>M12(high potted plants)</p>	<p>3</p>  <p>J08</p>	<p>4</p>  <p>K16</p>		
<p>11</p> 	<p>12</p>  <p>J20</p> <p>K12</p>	<p>5</p>  <p>About 4.5cm ~ 3cm, 3pieces in total.</p>	<p>6</p>  <p>M12(potted plants-2)</p>	<p>7</p>  <p>J08</p>	<p>8</p>  <p>N12</p> <p>Truncated 2 ~ 3 fascicles</p>		
<p>9</p>  <p>J19</p>	<p>10</p>  <p>N18</p> <p>K17</p>	<p>11</p>  <p>A28-63</p> <p>Fold in half along the dotted line and glue.</p>	<p>12</p> 	<p>13</p>  <p>Cut out each leaf.</p>	<p>14</p>  <p>Refer to the gray line and cut the effect as shown.</p>		

<p>15</p> 	<p>16</p>  <p>L10(6CM) L10(5CM) L10(4CM)</p>	<p>17</p>  <p>K16</p>	<p>18</p>  <p>L01 2CM</p>	<p>19</p>  <p>A28-61</p>	<p>20</p>  <p>M08 M08</p>
<p>21</p> 	<p>22</p>  <p>N03</p>	<p>Door and window</p> 		<p>1</p>  <p>D14 A28-52 Center Paste</p>	<p>2</p>  <p>In the same way, make 3pieces</p>
<p>23</p>  <p>N11</p>	<p>24</p>  <p>D13</p>	 <p>A28-52 D14 D14 D14 A28-77 M07(first floor door) A11 D15 D16</p>	<p>3</p>  <p>M07(first floor door) D15</p>	<p>4</p> 	
<p>Wooden shoe</p>  <p>Please cut out A26-1 in A26 before making.</p>  <p>A26-1 D17 D17 D17 D17 D18 D18 D18 D18 D18 D19 D19 D19 D19</p>  <p>A29-07 A29-08</p>  <p>A28-69</p>		<p>5</p>  <p>(front view)</p>	<p>6</p>  <p>A28-77 A11</p>	<p>7</p>  <p>D16</p>	<p>8</p> 
<p>1</p>  <p>D18 D17</p>	<p>2</p>  <p>D18</p>	<p>3</p>  <p>In the same way, make 2pieces</p>	<p>4</p>  <p>A29-07 A29-07</p>	<p>5</p>  <p>D19 D19</p>	<p>6</p>  <p>D17</p>

<p>8</p> <p>A29-08 A29-08</p>	<p>9</p> <p>A26-1 A28-69</p>	<p style="writing-mode: vertical-rl; transform: rotate(180deg);">Wall & Stairs & Raft</p>	<p>1</p> <p>A08 A07 6CM(long) 5.3CM Stick A08 on the long side</p>	<p>2</p> <p>A07 A08 A28-67 Fold A28-67 along the dotted line and bond with A07 + A08</p>	
<p>10</p>	<p>11</p> <p>Men's Shoes Lady's Shoes</p>		<p>3</p> <p>A10 A09 Fold A28-68 along the dotted line and bond with A09 + A10</p>	<p>4</p> <p>A09 A10 A28-68</p>	
<p>5</p> <p>E01 Paste stair to reference links</p>	<p>6</p> <p>E02</p>	<p>7</p> <p>E03</p>	<p>8</p> <p>E03 E04</p>	<p>9</p> <p>A11 (A11 wall panels have been made in the previous page.18)</p>	<p>10</p> <p>P01</p>
<p>11</p> <p>D10 (D10 wall lamp has been made in the previous page.15)</p>	<p>12</p> <p>L19 20CM</p>	<p>13</p>	<p>14</p>	<p>15</p> <p>In the same way, make 3pieces</p>	<p>16</p> <p>L20 20CM*2pieces L20 13CM*2pieces</p>
<p>17</p> <p>Refer to the previous steps to make L20, and place it for later up</p>	<p>18</p> <p>A28-66 A15</p>	<p>19</p>	<p>20</p> <p>E05 E05</p>	<p>21</p> <p>E05 E05</p>	<p>22</p> <p>L19 L19 L19</p>

Outer Frame Assembly

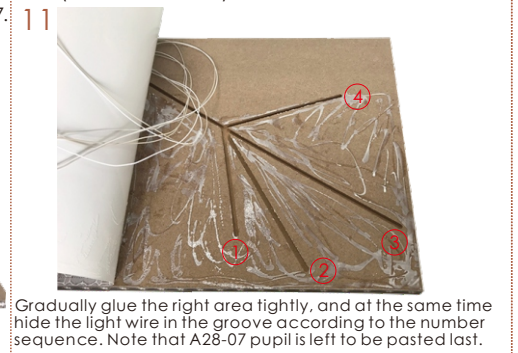
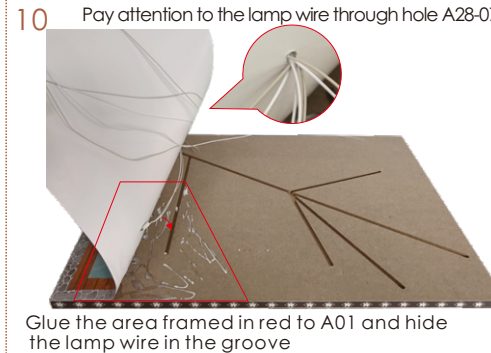
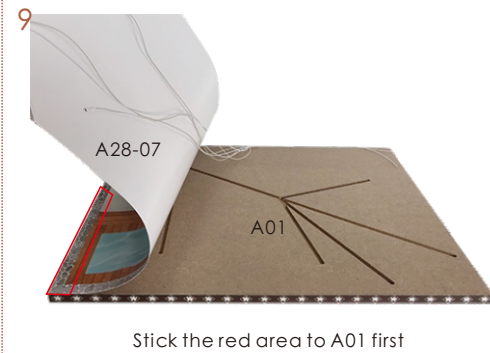
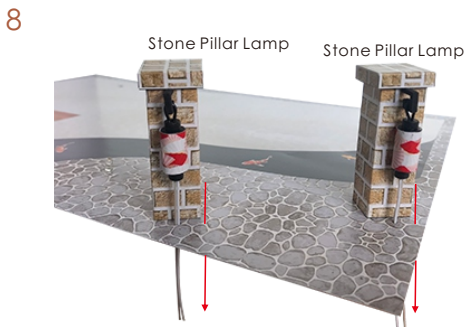
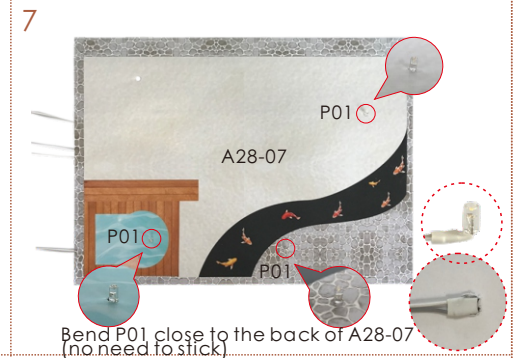
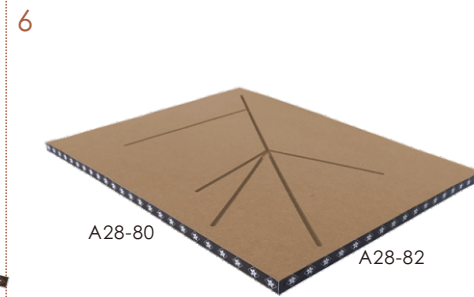
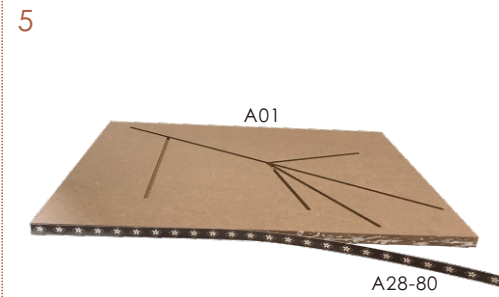
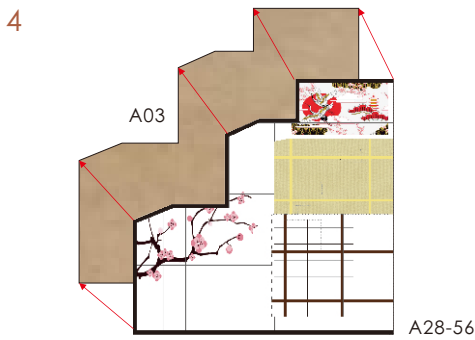
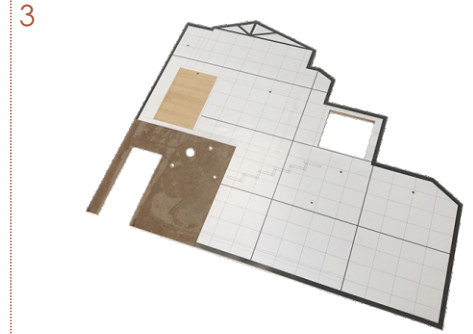
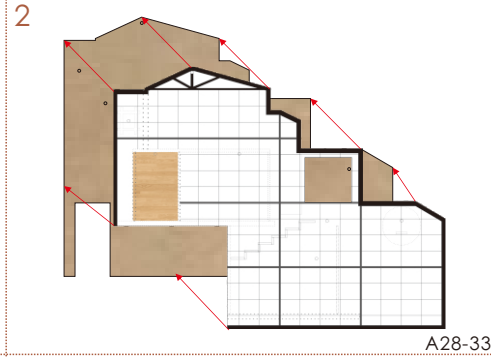
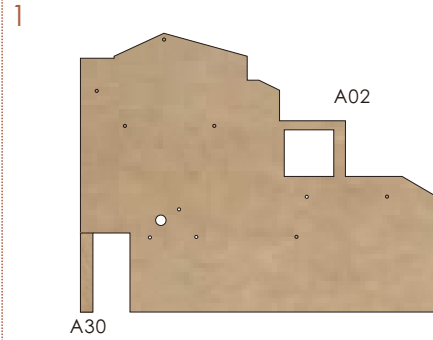

14 upgraded version (accessories need to be purchased separately)

 <p>Q01 music movement (1piece)</p>	 <p>Q02 movement screws (3pieces)</p>	 <p>Q03 movement handle (1piece)</p>
--	--	---

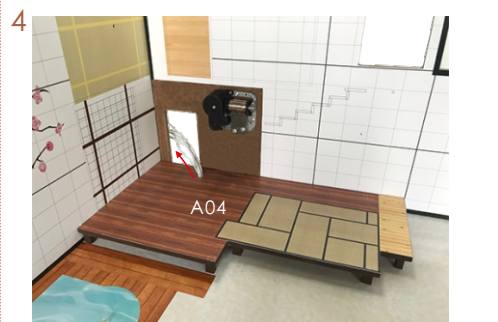
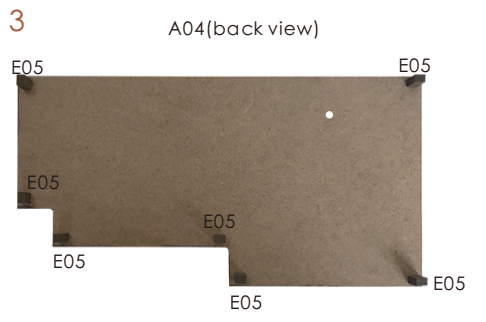
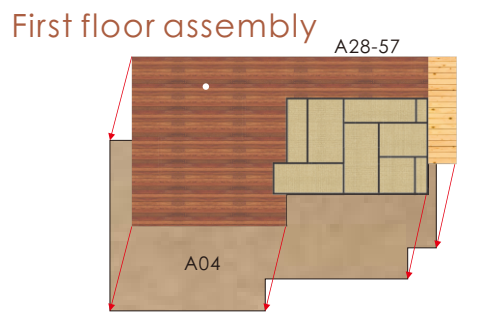
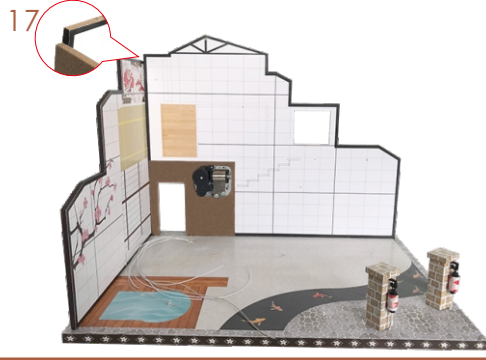
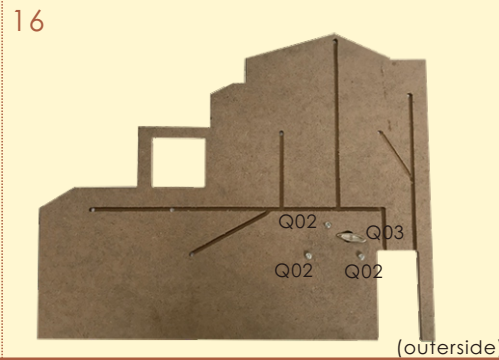
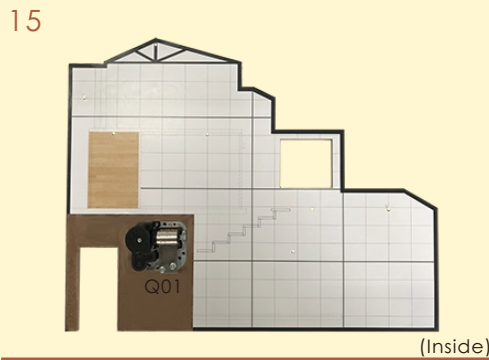

Pay attention to put the lamp wire on the ground through the A04 hole.

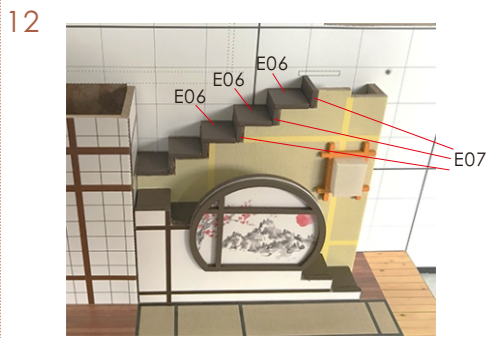
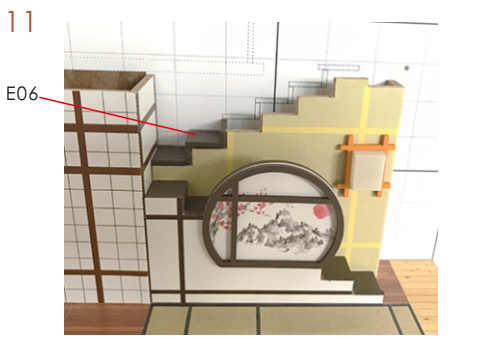
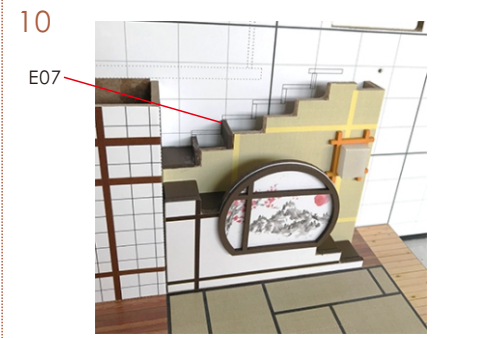
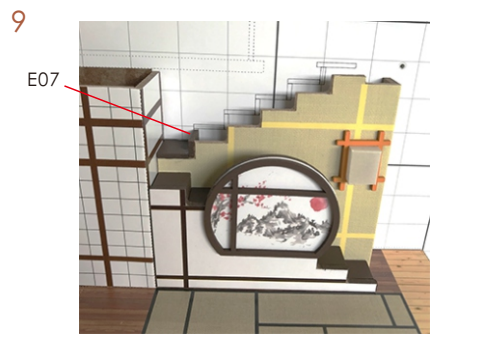
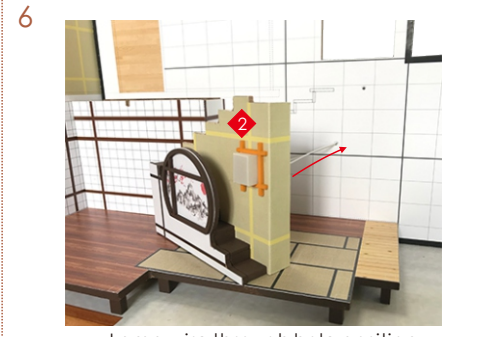
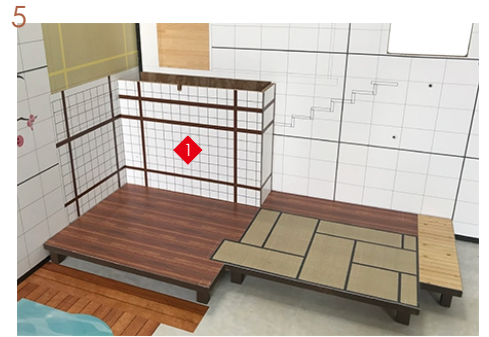

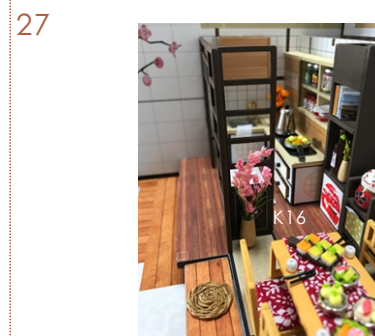
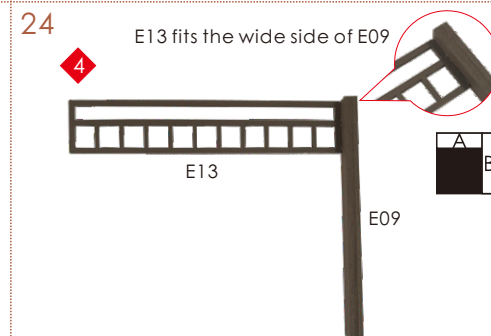
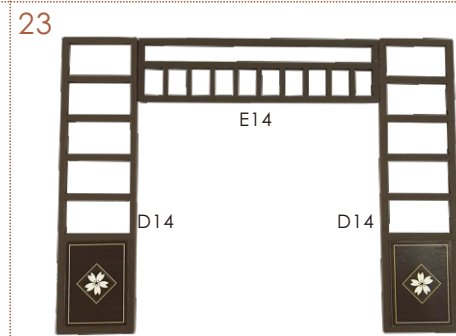
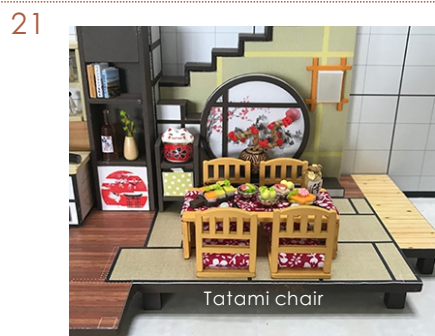
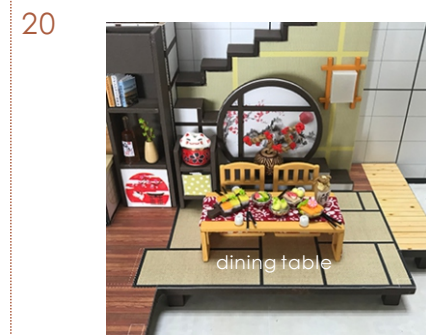
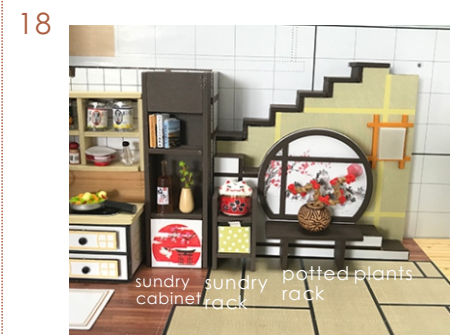

(K16 potted plants have been made in the previous page 17.)



Bathroom Wall Panel



Please bend according to L08 template before making.

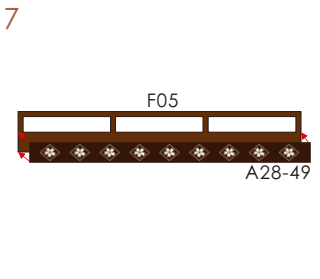
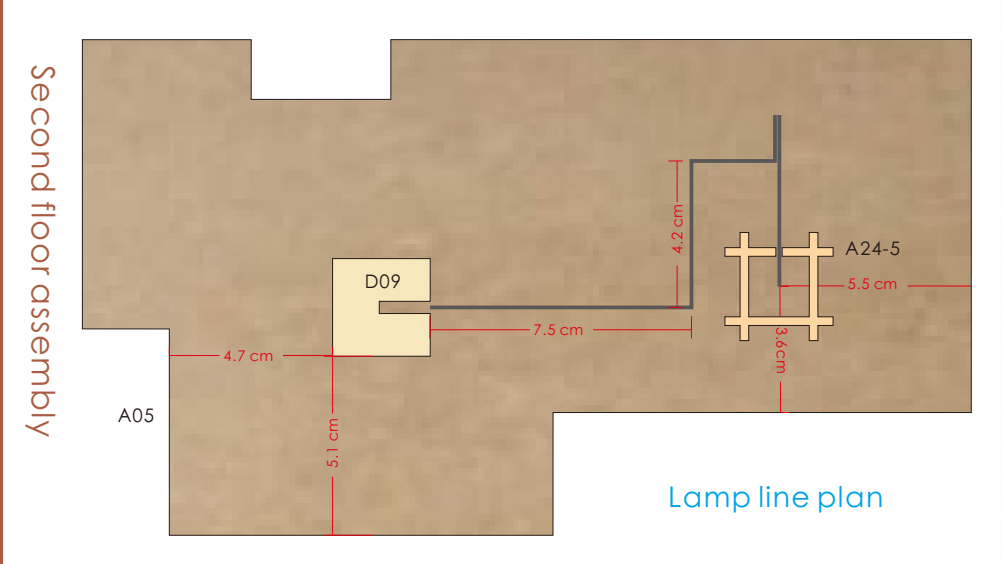
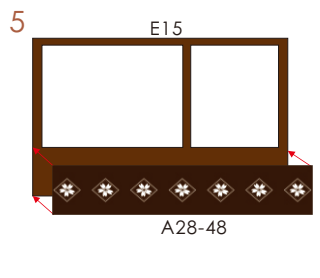
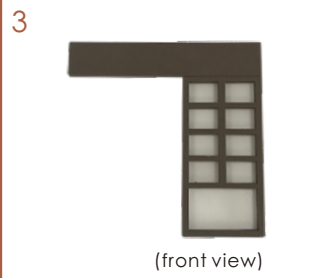
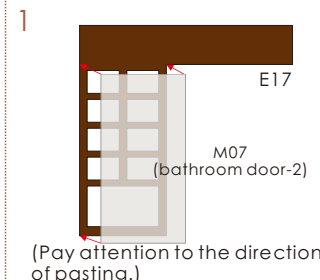
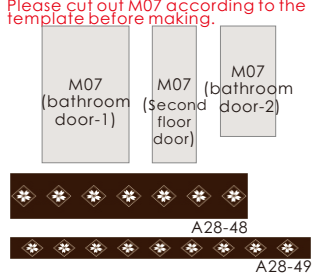
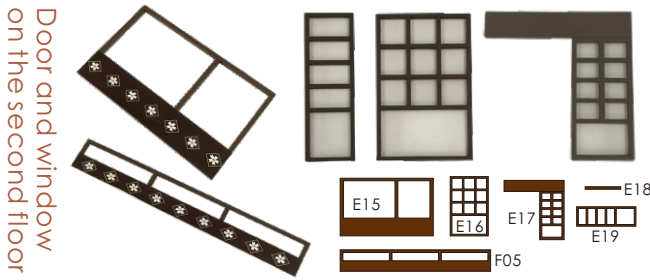
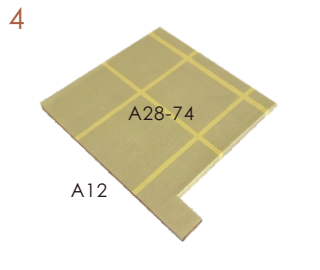
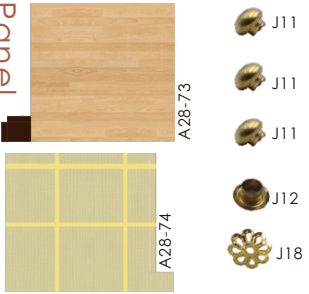
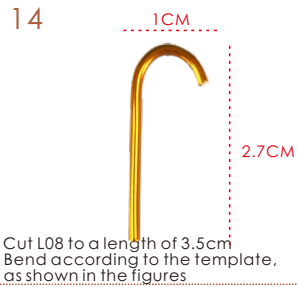
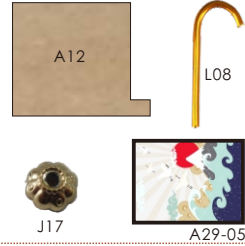

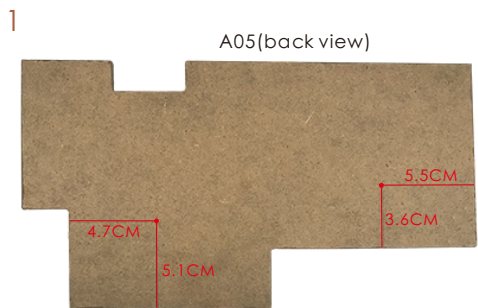

Mark a dot accord to that distance of the above data.

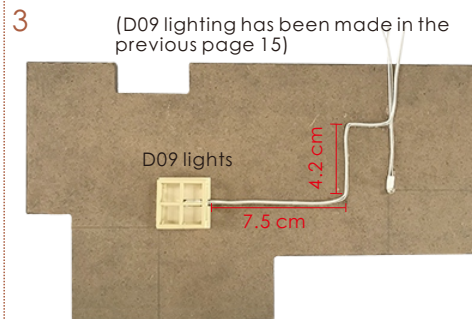
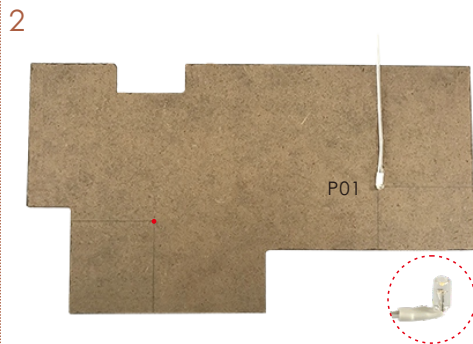

According to the above data, bend and stick the lamp wire as shown in the figure.

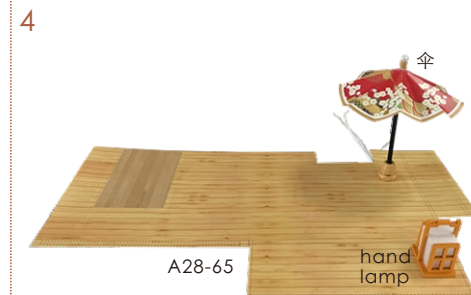

Affix the umbrella and hand lamp made in front to A28-65 according to the reference links.

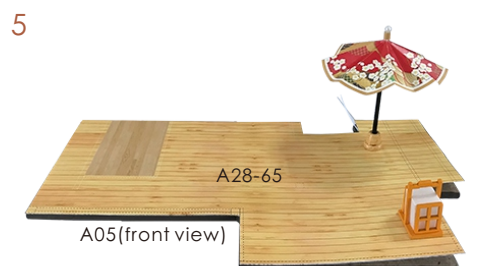

Stick A28-65 to A05 from left to right, and hide the lamp wire in the groove (for the convenience of operation, the left side can be raised, and the A05 can be balanced on a horizontal plane).

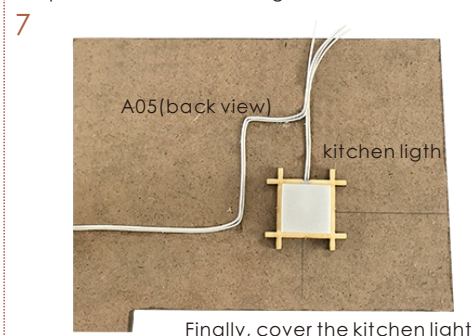
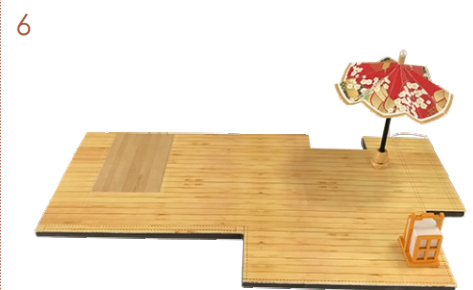

Pay attention to the light line.



Paste stair to reference links.

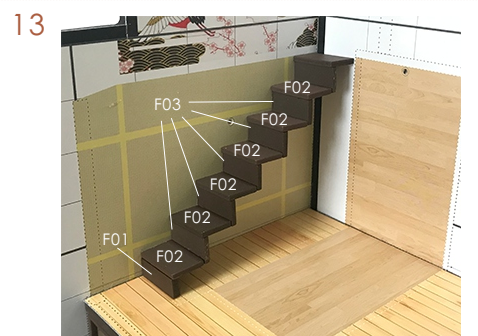

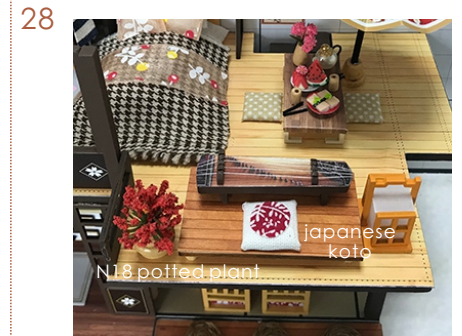
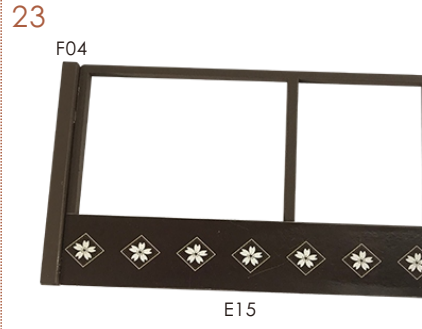

Glue F08 with reference to the reference line on the ground

Roll off part of A28-50 from the bottom as shown.

Fold up along the dotted line.

Roof Tile

Please cut out A27 according to the template before making. (pay attention to the cutting direction of corrugated paper!)

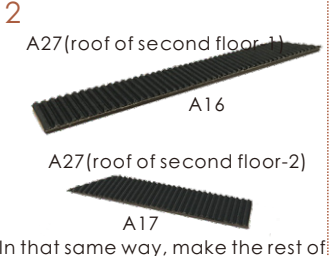
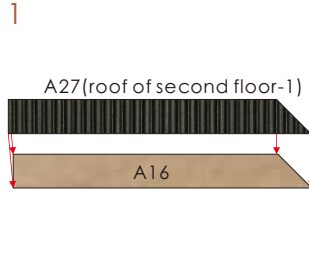
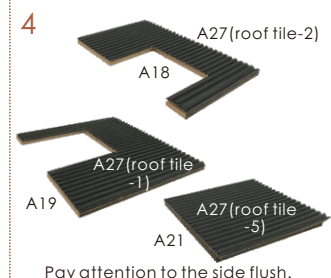
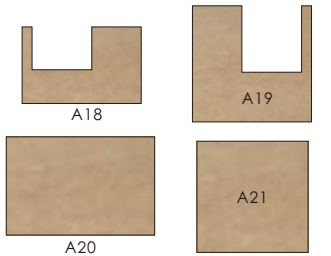
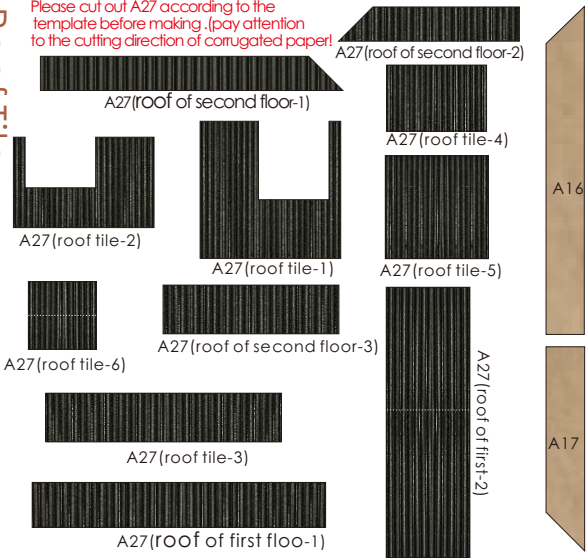

Windows, doors and lighting on the third floor

Please cut out M01 and M07 according to the template before making. Please cut out 24-1 in A24 before making.

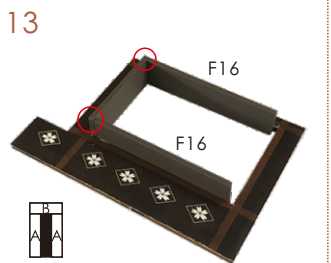
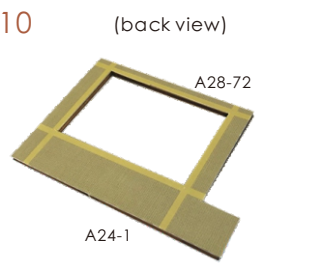
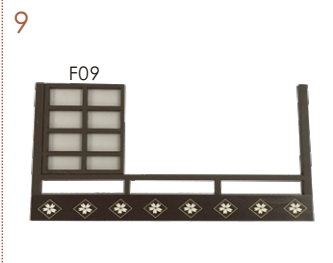
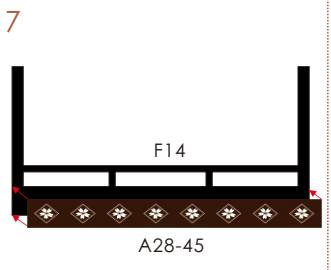
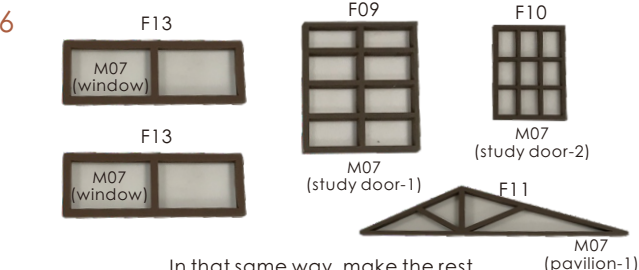
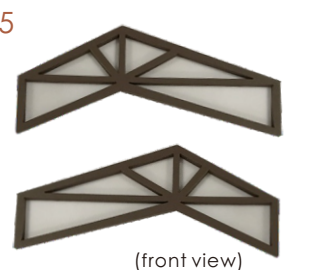
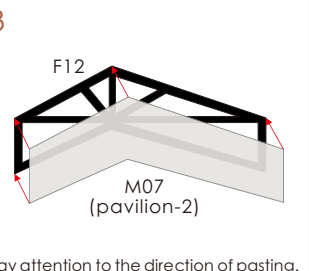
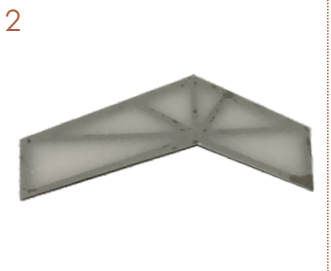
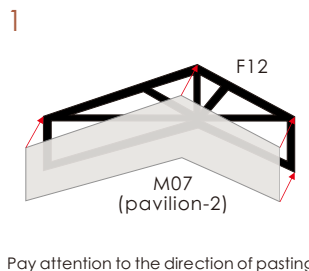
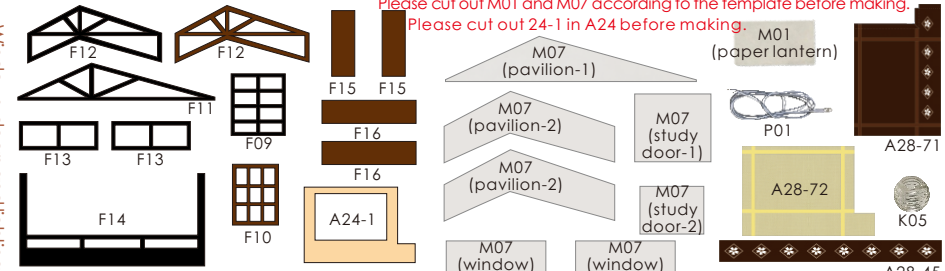

<p>15</p> <p>F10 (back view)</p> <p>(A24-1 back view)</p>	<p>16</p> <p>(A24-1 front view)</p>	<p>17</p> <p>K05 M01</p> <p>Wrap K05 with M01 and tighten both end. (Pay attention to the hole position of K05. Align both ends and then screw it.)</p>	<p>19</p> <p>Trim off the excess at both ends of M01.</p>	<p>20</p> <p>P01</p>	<p>21</p> <p>4.2CM 2.5CM</p> <p>According to the above data, bend the lamp line as shown in the figure.</p>
<p>22</p> <p>1CM 2CM 1.5CM</p> <p>A21 (back view)</p> <p>Glue the line in the yellow line area to A21.</p>	<p>23</p> <p>F12 F13</p>	<p>24</p> <p>F12 F13</p>	<p>25</p> <p>back view</p> <p>F12</p>	<p>26</p> <p>A21 F12</p>	<p>27</p> <p>A20</p>

Third floor assembly

1

A06
A28-27

2

A14

3

4CM
P01
4.3CM
A06 (back view)

4

K05

5

G01
G02

6

A28-76
A14

7

A28-76
A14

8

Pay attention to the light line.

9



(D10 wall lamp has been made in the previous page 15.)



Paste according to the guide line on the floor.

(The large hemp rope seat cushion has been made on the previous page 19.)



A27 (roof tile-3) has been cut out on previous page 26

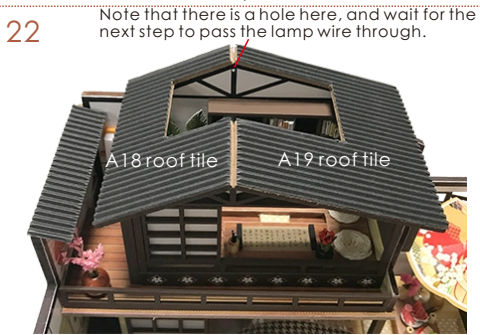

Note that there is a hole here, and wait for the next step to pass the lamp wire through.



Pay attention to the position of the lamp wire of the pendant lamp through the hole as shown in the figure.

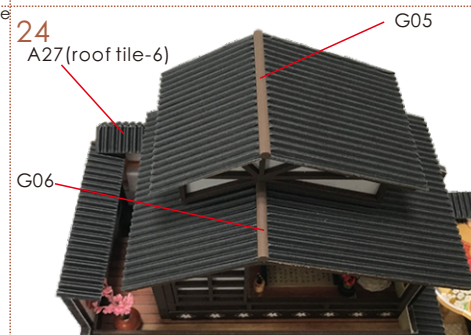

A27 (roof tile-6) has been cut out on previous page 26



A27 (roof of second floor-3) has been cut out on previous page 26

26

G04

27

E10

A27 (roof of first floor-1)

E10

A27 (roof on the first floor-1) has been cut out on the previous page 26

28

A27 (roof of first floor-2)

(Note the short side against the wall.)

29

G07

N12 plant

30

A16

A17

Place A16 and A17 at the same time so that they can be combined with the interface point

31

E1

E1

32

G16

33

N16

cut out the area below the red links

34

N16

N01

35

N16

cut out the area below the red links

36

N16

G16

You can match the branches that have been pruned before in the sparse place.

37

N15

N15

N15

N15

N15

N15

38

N15

N01

39

A28-59 (lantern)

A28-59 (lantern)

wooden shoe

40

G17

G17

G17

L01 potted plant

41

L01 potted plant

G08

Hot spring

G09

G10

G14

G11

G11

G11

G11

G15

G13

G12

G12

J01

J01

Please cut out A23-8 in A23 before making
Please cut out A27 according to the template
before making (pay attention to the cutting
direction of corrugated paper)

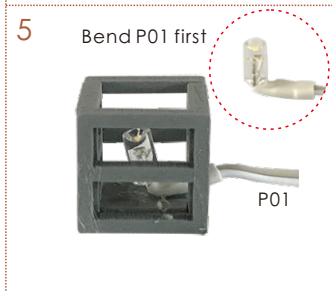
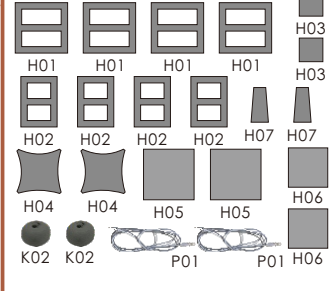
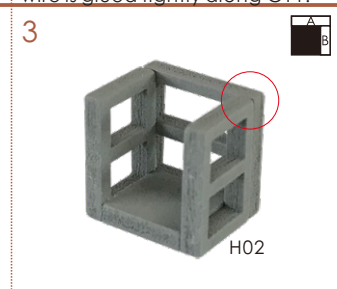
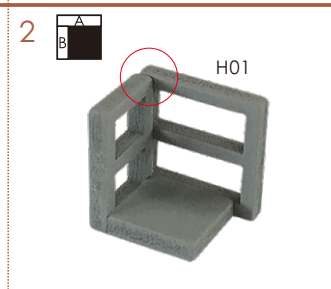
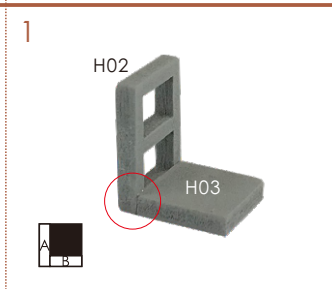
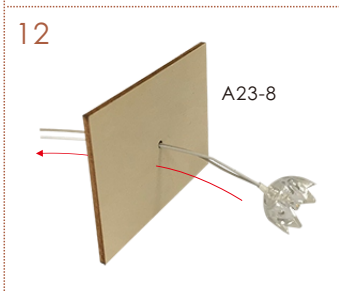
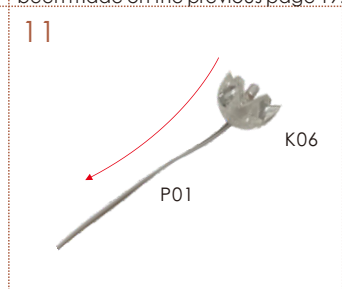
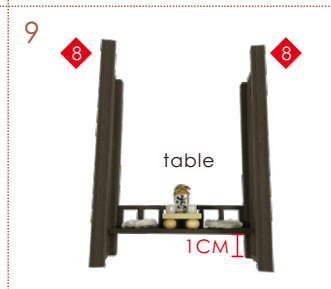
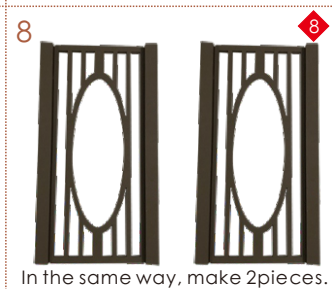
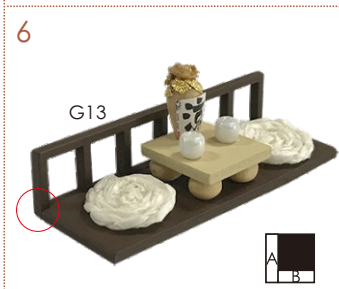
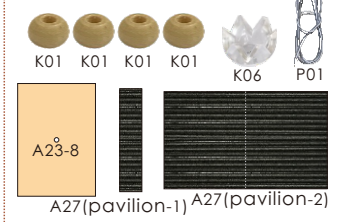

9

Stick to H06 center.

10

In the same way, make 2pieces.

Rockery

Please cut out A26-4 in A26 before making.
Please cut out M18 according to the template before making.

H07, H06, A26-4, H14, K15, P01, N08, N10, L07, M18 (PVC), A28-29, A28-30, A28-31, A28-81, A28-32

1

H14, N08

2

N10

3

L07, A28-30, A28-31

4

M18 (PVC)

5

P01

6

Pay attention to the light line.

(back view)

7

wreath

8

N08, K15

Plants

Please cut out A26-3 in A26 before making.

A26-3, N01, N04, N13, L19, N23, N20, N20, N20, N20, A29-12, A28-75

9

A26-4, A28-32

10

A28-81

11

A28-29

12

A28-29

5

N13, L19

Trim several bunches of N13 approx. 11 cm high and tie together with L19.

6

N13

7

N20

8

N23, N23

In the same way, make 2pieces.

9

N20

cut off the area below the red links

10

N23, N23

In the same way, make 2pieces.

Garden accessories

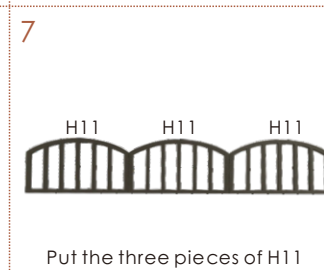
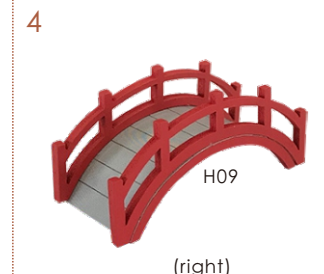
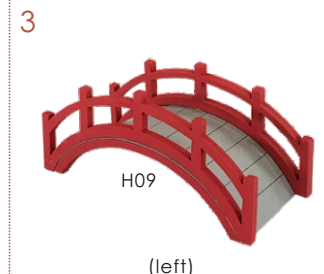
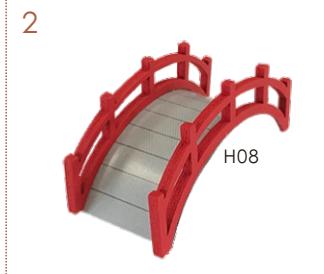
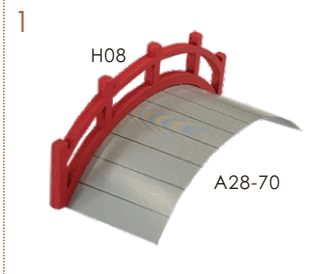
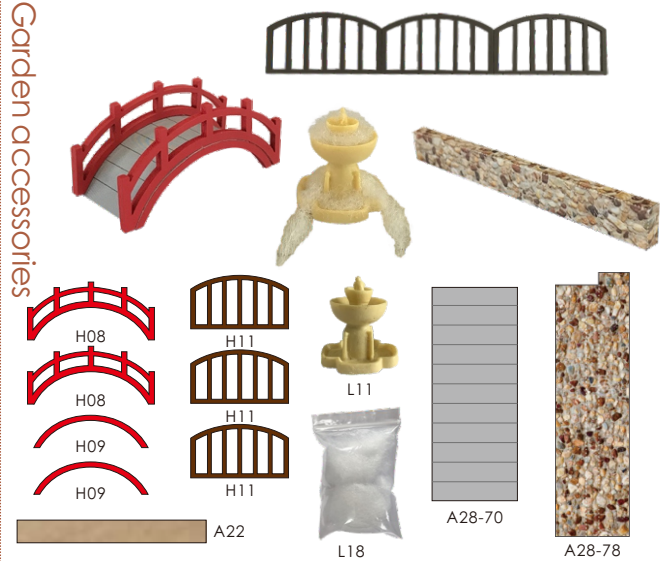

Put the three pieces of H11 side by side

Add appropriate amount of L18 to the concave part, make the feeling of flowing like water mist.

Garden assembly



Pay attention to the wiring of the lamp line, and finally go out through the backplane.



Tile L18 on top



Spa bucket



A28-39



Cut the white line.



ground lamp

ground lamp

Pay attention to the wiring of the lamp line, which finally passes through the back of the backplane.



N19

N19



10

Please cut out M02 (pool) according to the template before making.



11

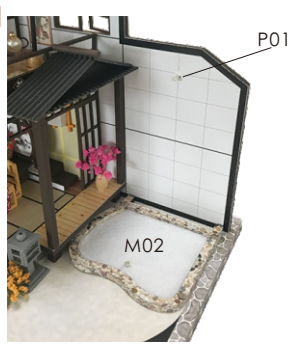

12



13

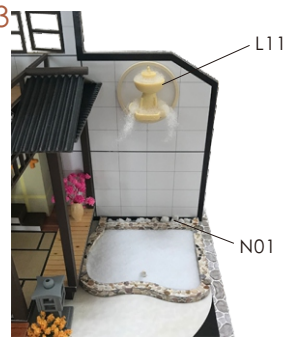

14



Pay attention to the lamp wire to the back of the backplane (you can gently play a small solution at the end of the lamp wire to facilitate the lamp wire through the backplane).

15



Trim N06 to a height of approx. 11cm from the bottom.

16

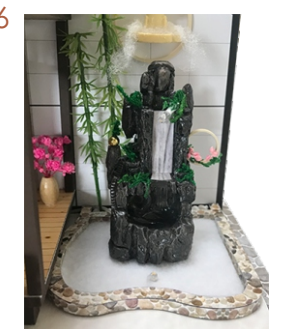

Add appropriate amount of N08 moss

17



Add proper amount of L18 (cotton) wool mist

18

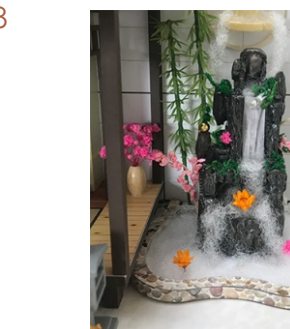

Add N11, N14 flower buds, one N10, two N20.

19



20



Before making, please cut out A27 (courtyard tile roof) according to the template.

21

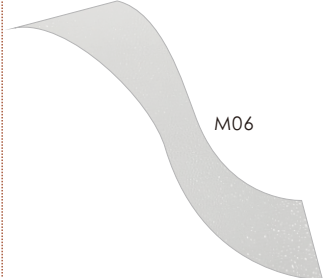

Please cut out M06 according to the template before making.

22



Fit the four sides of M06 against the stream.

23



Add a layer of glue to both sides of M06 and lay down a layer of N24 grass powder

24



25



26





Affix N01 all the way around.

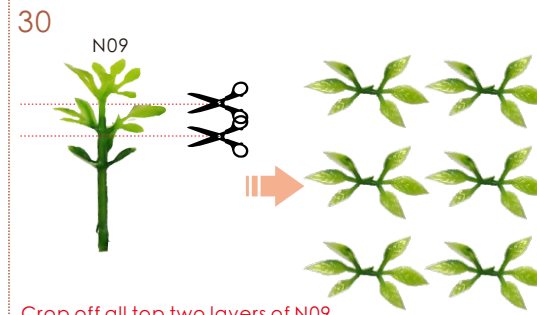

Crop off all top two layers of N09.



Add N09 on the riverside as shown in the figure.

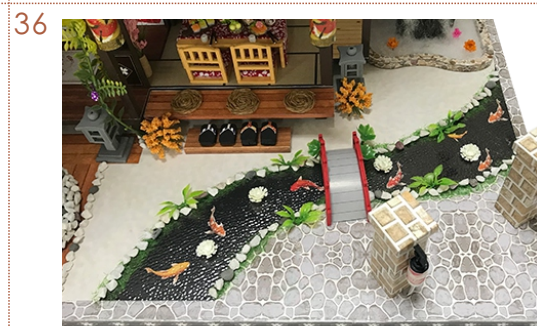
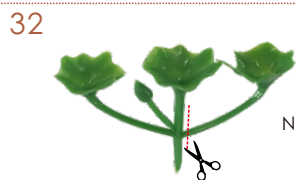

Put the stamens of N17 on the stream.



The floor lamp shade has been made on the previous page.15.

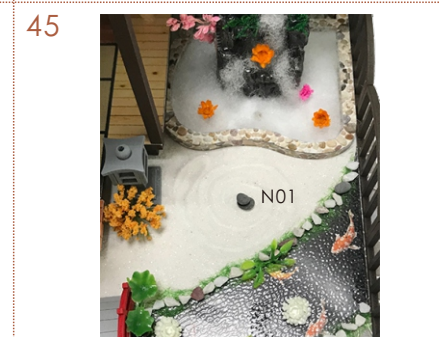
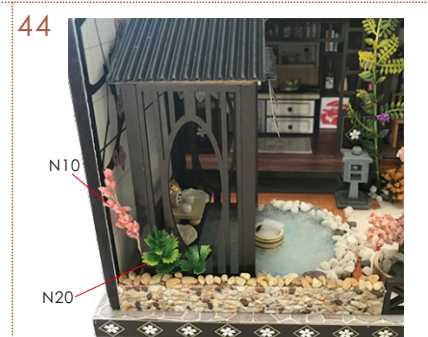
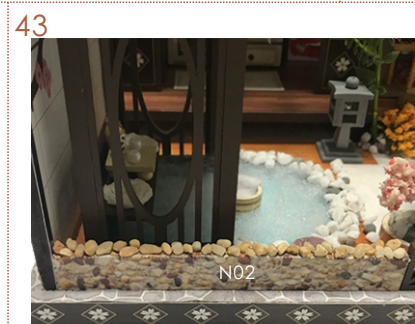
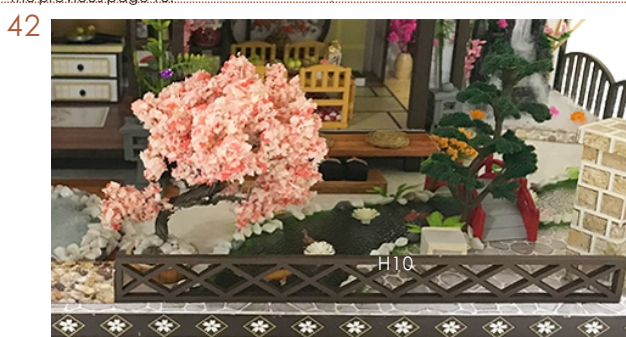

Add N03 sand on the white floor



A29-02
You can write your favorite door number!

How to assemble the battery holder

2



Hide the lamp wire in the groove.

3

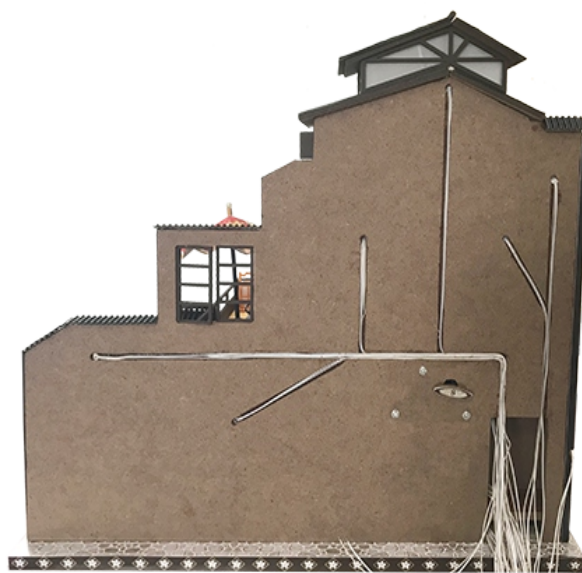

Arrange the lamp wire and hide it in the groove.



4 Take care to unscrew Q03 first and then attach A28-43.



5

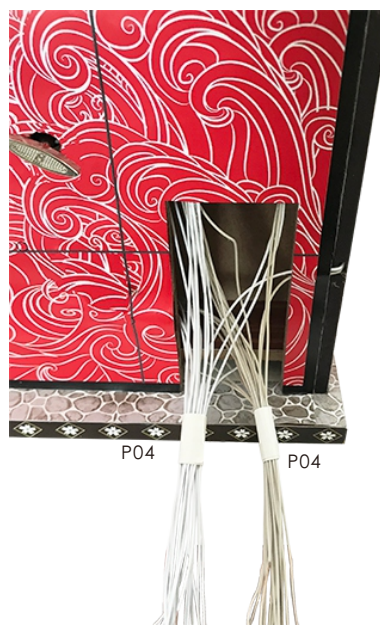

Distinguish the light lines of the same color.

6



cut all the LED light wires to the same length
peel off the film of the LED light wires and then wrap it together in the same color.

7

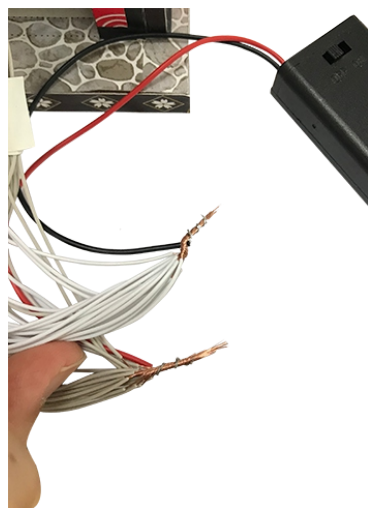

Put all gray wires with battery box red wires together ,and put all white wires with battery box black wire together
Wrap the bare wires with adhesive tape P04.
Make sure the LED lights are on.

8

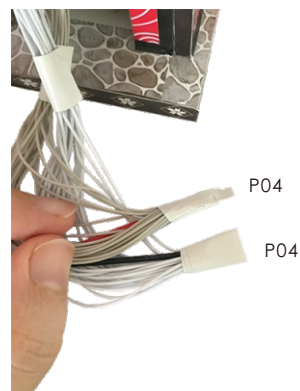

Statement: the lamp wires cannot be inserted into the output socket.

- Can use 2*AAA batteries
- Please notice the place of anode and cathode when pit in the batteries
- Rechargeable batteries are not blunt electricity
- Rechargeable batteries can only be charged under adult supervision
- Rechargeable batteries should be removed from the toy before charging
- Different types of batteries cannot mix;
- Do not mix new batteries in use with semi-used batteries.
- Run out of battery should be removed from the toy
- The power shall not be short circuit

9



Put the battery holder in it
(be careful not to touch the wind-up of the music machine).



Great! Your large villa is finished.!



With dust cover at night



Installation of dust cover

dust cover
(Upgrade version accessories need to be purchased separately)

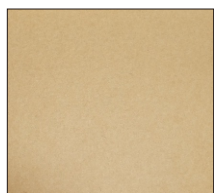

scale:1:13
Q04 plexiglass(transparent)
35.5*32*0.18(2pieces)



scale:1:13
Q05 plexiglass(transparent)
32*25.64*0.18(2pieces)



scale:1:13
Q06 plexiglass(transparent)
35.5*26*0.18(1piece)

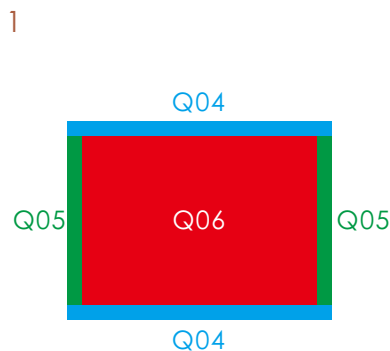

stick Q04 and Q05 on Q06

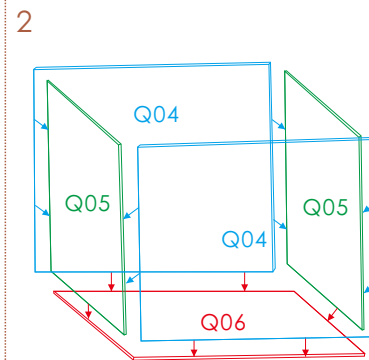

stick five pieces of plexiglass dust cover as shown



Take out the plexiglass and tear off the kraft paper with text on each piece of plexiglass

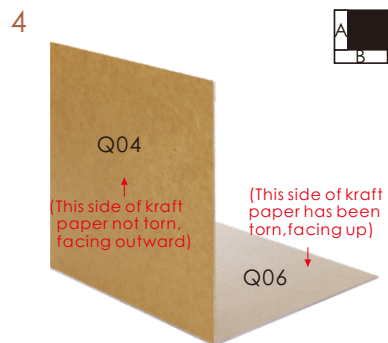

The kraft paper that has been ripped off faces inwards, and the kraft paper that has not been ripped out faces outwards.

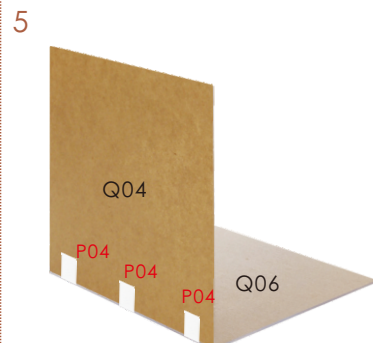

Use P04 to fix the junction of two pieces of plexiglass. (use transparent tape to replace P04)

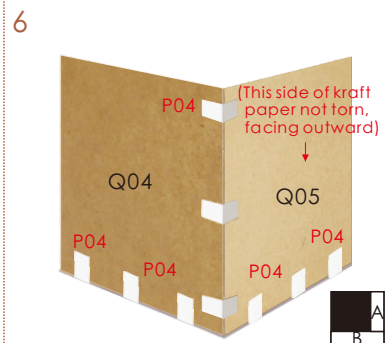

The junction of every two pieces of plexiglass needs to be fixed with P04 (to prevent the plexiglass falling off)

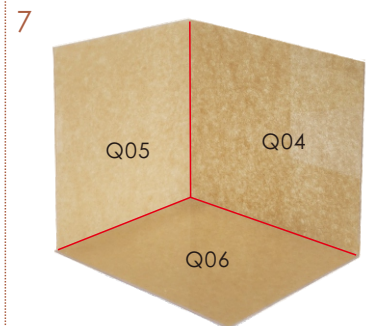

stick appropriate amount of glue to the interface of the two pieces of glass and scrape it slightly to make the glue penetrate into the junction of the two pieces of glass (the red line is the plexiglass interface)

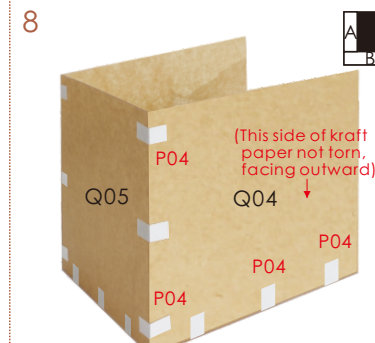

The junction of two pieces of plexiglass needs to be fixed with P04 (to prevent the plexiglass falling off)

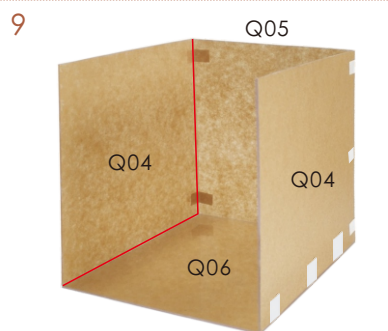

stick appropriate amount of glue to the interface of the two pieces of glass and scrape it slightly to make the glue penetrate into the junction of the two pieces of glass (the red line is the plexiglass interface)

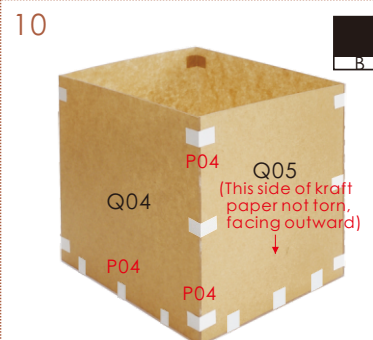

The junction of two pieces of plexiglass needs to be fixed with P04 (to prevent the plexiglass falling off)

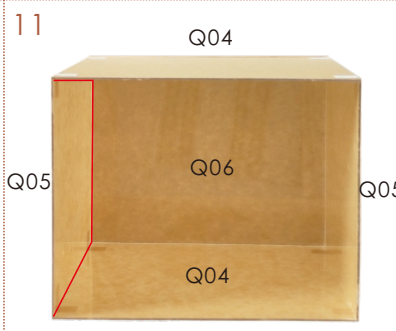

stick appropriate amount of glue to the interface of the two pieces of glass and scrape it slightly to make the glue penetrate into the junction of the two pieces of glass (the red line is the plexiglass interface)

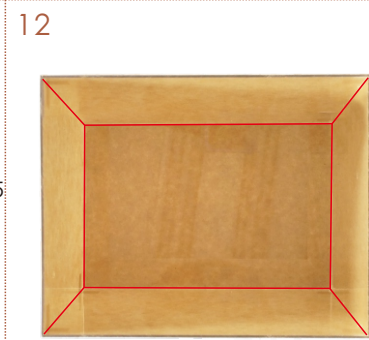

the dust cover need to be glued 8 interfaces

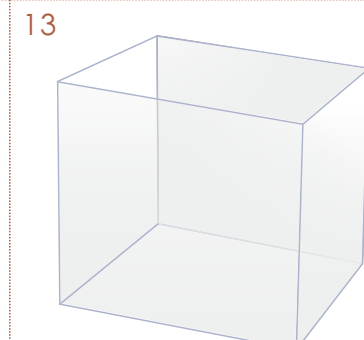

Leave it for 1 hour. After the glue dries out, tear off a layer of kraft paper outside the plexiglass



The instruction manual should be keep after assembled